

Gas Chromatograph Mass Spectrometer

GCMS Consumables

UFMS
ULTRA FAST MASS SPECTROMETRY

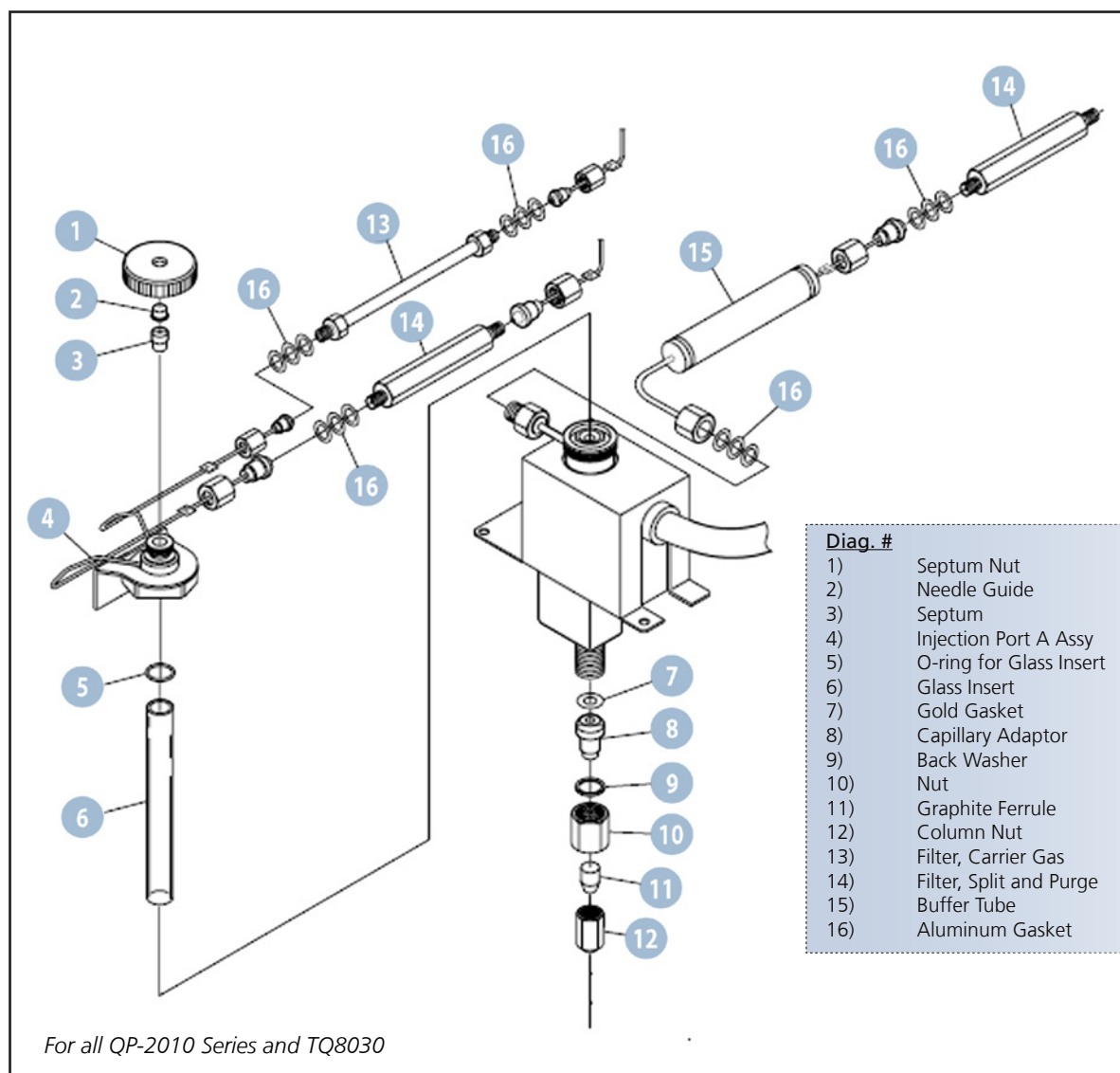



- Diag. #**
- 1) Septum Nut
 - 2) Needle Guide
 - 3) Septum
 - 4) Injection Port A Assy
 - 5) O-ring for Glass Insert
 - 6) Glass Insert
 - 7) Gold Gasket
 - 8) Capillary Adaptor
 - 9) Back Washer
 - 10) Nut
 - 11) Graphite Ferrule
 - 12) Column Nut
 - 13) Filter, Carrier Gas
 - 14) Filter, Split and Purge
 - 15) Buffer Tube
 - 16) Aluminum Gasket

















Injection Port

Diag. #	Part No.	Name	Description
1	221-72615-00	Septum Nut, GC-2010 series	Works for all GC-2010/QP-2010 series
2	221-44584-00	Needle Guide	Needle guide used for all GC and GCMS
7	221-49065-91	Gold Gasket	Gasket used for sealing the adapter to the base, 5/pk
8	225-10167-91	Injection port capillary adaptor	Adaptor for connecting capillary columns
11	220-90418-14	Ferrule: GVF-004	Capillary MS ferrule for 0.25mm id columns, 10/pk
11	220-90418-15	Ferrule: GVF-005	Capillary MS ferrule for 0.32mm id columns, 10/pk
11	220-90418-18	Ferrule: GVF-008	Capillary MS ferrule for 0.53mm id columns, 10/pk
12	670-11009-00	Column nut	Column nut 1/16" for GC and MS (on MS systems), 5/pk
11&12	220-94773-00	SilTite nut and ferrule kit	Capillary MS nut and ferrule set for 0.25mm id columns, 2 nuts and 10 ferrules
13	221-34121-93	Filter, carrier gas	Filter for incoming carrier gas, MS-5A
14	221-42559-92	Filter, split and purge	Filter for outgoing gas through split and purge, silica gel
14	221-42595-92	Filter, split and purge for harsh solvents	Filter for outgoing gas through split and purge, activated carbon
16	201-35183-00	Aluminum Gasket	Gasket used for sealing the G-fittings, 100/pk

Septa / O-ring

Diag. #	Part No.	Name	Description
3	221-48398-91	Septa, Red	High temperature (350 deg C +), 25/pk
3	220-90638-00	Septa, Blue	Low temperature (up to 250 deg C), 25/pk
3	220-94781-00	Septa, Thermogreen	Medium temperature (up to 340 deg C), 50/pk
3	220-90547-00	Septa, Thermolite	Medium temperature (up to 340 deg C), 50/pk
3	220-94792-00	Septa for Pyrolysis	High temperature for use with Frontier Pyrolyzer, 5/pk
5	036-11201-84	O-ring for liner	O-ring for sealing OCI liner, 5/pk
5	036-11203-84	O-ring for liner	O-ring for sealing glass liners, fluoride rubber (up to 450 deg C), 5/pk
5	221-47222-91	Graphite o-ring for liner	Graphite o-ring for splitless/WBI, high temperature (350-450 deg C), 4/pk
5	221-48393-91	Graphite o-ring for liner	Graphite o-ring for split, high temperature (350-450 deg C), 4/pk
5	221-49662-91	O-ring for liner when using a pyrolyzer	O-ring for sealing glass liners when using a pyrolyzer, 5/pk

Glass Inserts / Liners

Diag. #	Part No.	Name	Description	
6	220-90784-00	Split liner with wool	General purpose split liner with wool, 5/pk (replaces 220-94590-00)	
6	220-90784-25	Split liner with wool	General purpose split liner with wool, 25/pk	
6	220-94766-00	Split liner for focusing	Liner used for focusing a split injection with wool, 5/pk	
6	221-41444-01	Split liner w/o wool	General purpose split liner w/o wool, 1/pk	
6	220-94767-00	Splitless liner for focusing	Liner used for focusing a splitless injection, 5/pk	
6	221-48876-02	Splitless liner with wool on top	Splitless liner with wool and tapered bottom, 5/pk (liner included in GCMS from SSI)	
6	221-48876-03	Splitless liner with wool on bottom	Splitless liner with wool and tapered bottom, 5/pk	
6	220-94734-01	Splitless drilled uniliner with hole near the top	Liner used for splitless analysis for chlorinated pesticides, aqueous injection and compounds of interest that elute away from tailing solvent peak, 5/pk	
6	220-94734-02	Splitless drilled uniliner with hole near the bottom	Liner used for splitless analysis for volatile compounds that elute near the tailing solvent peak, 5/pk	
6	220-94734-03	Splitless gooseneck drilled uniliner with hole at the top	Liner used for splitless analysis for chlorinated pesticides, aqueous injection and compounds of interest that elute away from tailing solvent peak; top restriction used to hold sample cloud for greater column loading, 5/pk	
6	220-94734-04	Splitless gooseneck drilled uniliner with hole at the bottom	Liner used for splitless analysis for volatile compounds that elute near the tailing solvent peak, top restriction used to hold sample cloud for greater column loading, 5/pk	
6	220-94735-01	Direct injection liner with wool on bottom	Liner for direct injections of dirty samples, wool acts as a filter, 5/pk	
6	220-94768-00	Mega-bore liner w/o wool	Liner for megabore columns (0.53mm), 5/pk	
6	220-94769-00	Low volume liner	Liner for SPME or Purge and Trap applications, 5/pk	
6	221-49381-02	OCI glass liner	Liner for 'simple on-column' or 'near on-column', for use with columns smaller than 0.53mm id, 1/pk	
6	221-49300-00	LVI/PTV glass liner	Liner for large volume pvt injections on a capillary column w/o wool, 1/pk	
6	221-49298-91	OCI metal liner	Liner for true on-column injection with columns 0.53mm id, 1/pk	

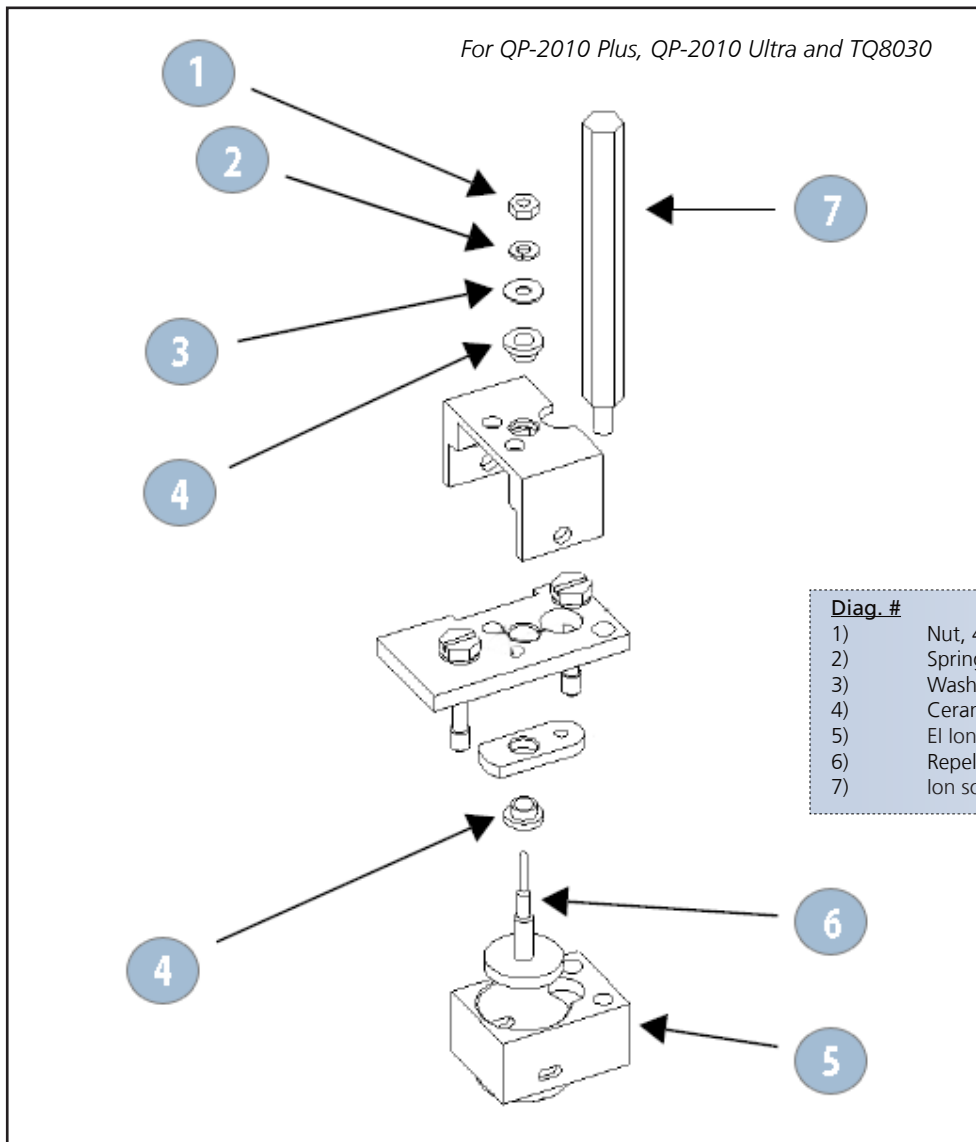

- Diag. #**
- 1) Nut, 4mm
 - 2) Spring Washer
 - 3) Washer
 - 4) Ceramic Insulator
 - 5) EI Ion Box
 - 6) Repeller
 - 7) Ion source removal tool

Ion Source

Diag. #	Part No.	Name	Description
1	023-04020-00	Nut, 4mm	Repeller securing nut
2	023-77020-00	Spring washer	Repeller washer
3	023-66120-00	Washer	Repeller washer
4	225-01068-00	Ceramic insulator	Ceramic insulator bushing for repeller
5	225-17697-91	EI Ion Source	EI Ion Source for QP-2010 Plus/ 2010 Ultra/TQ8030 (shown)
5	225-17705-91	CI Ion Source	CI Ion Source for QP-2010 Plus/ 2010 Ultra/TQ8030 (not shown)
5	225-17705-92	NCI Ion Source	NCI Ion Source for QP-2010 Plus/ 2010 Ultra/TQ8030 (not shown)
6	225-17698-91	Repeller	Repeller for QP-2010 Plus/2010 Ultra/TQ8030
6	225-17659-91	Repleller Assembly	Repeller assembly for QP-2010 Plus/2010 Ultra/TQ8030
6	225-17711-91	Repeller 2, CI + DI ©	Repeller for TQ8030 for CI Analysis with DI
7	225-10194-91	Ion source removal tool	For removing the ion source from the MS
	225-10340-91	Filament	Filament (not shown), 1/pk
	225-10238-00	Filament Nut	Filament retaining nut (not shown)

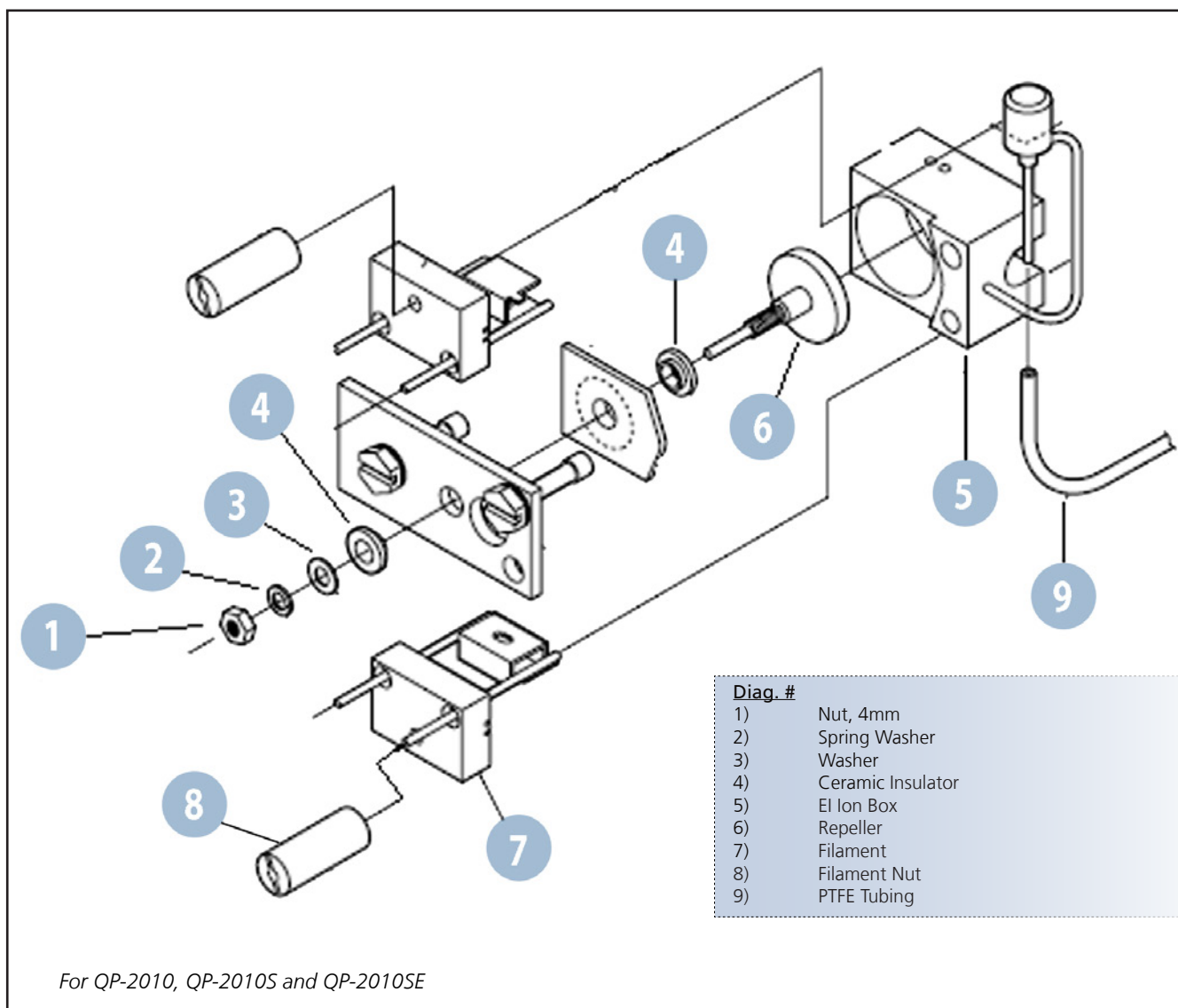

NOTE: CI source for QP-2010 (shown), QP-2010S and QP-2010SE are similar but without CI parts

Ion Source

Diag. #	Part No.	Name	Description
1	023-04020-00	Nut, 4mm	Repeller securing nut
2	023-77020-00	Spring washer	Repeller washer
3	023-66120-00	Washer	Repeller washer
4	225-01068-00	Ceramic insulator	Ceramic insulator bushing for repeller, 1/pk
5	225-10446-91	EI Ion Source	EI Ion Source for QP-2010/2010 S/2010 SE (not shown)
5	225-10617-91	CI Ion Source	CI Ion Source for QP-2010 (shown)
5	225-10617-92	NCI Ion Source	NCI Ion Source for QP-2010 (not shown)
6	225-10447-91	Repeller	Repeller for QP-2010/2010 S/2010 SE
6	225-10442-91	Repeller Assembly	Repeller assembly for QP-2010/2010 S/2010 SE
7	225-10340-91	Filament	Filament for all QP-2010 series instruments, 1/pk
8	225-10238-00	Filament Nut	Filament retaining nut
9	016-37575-03	PTFE Tubing	Reagent gas supply line for CI/NCI source, 10 meters

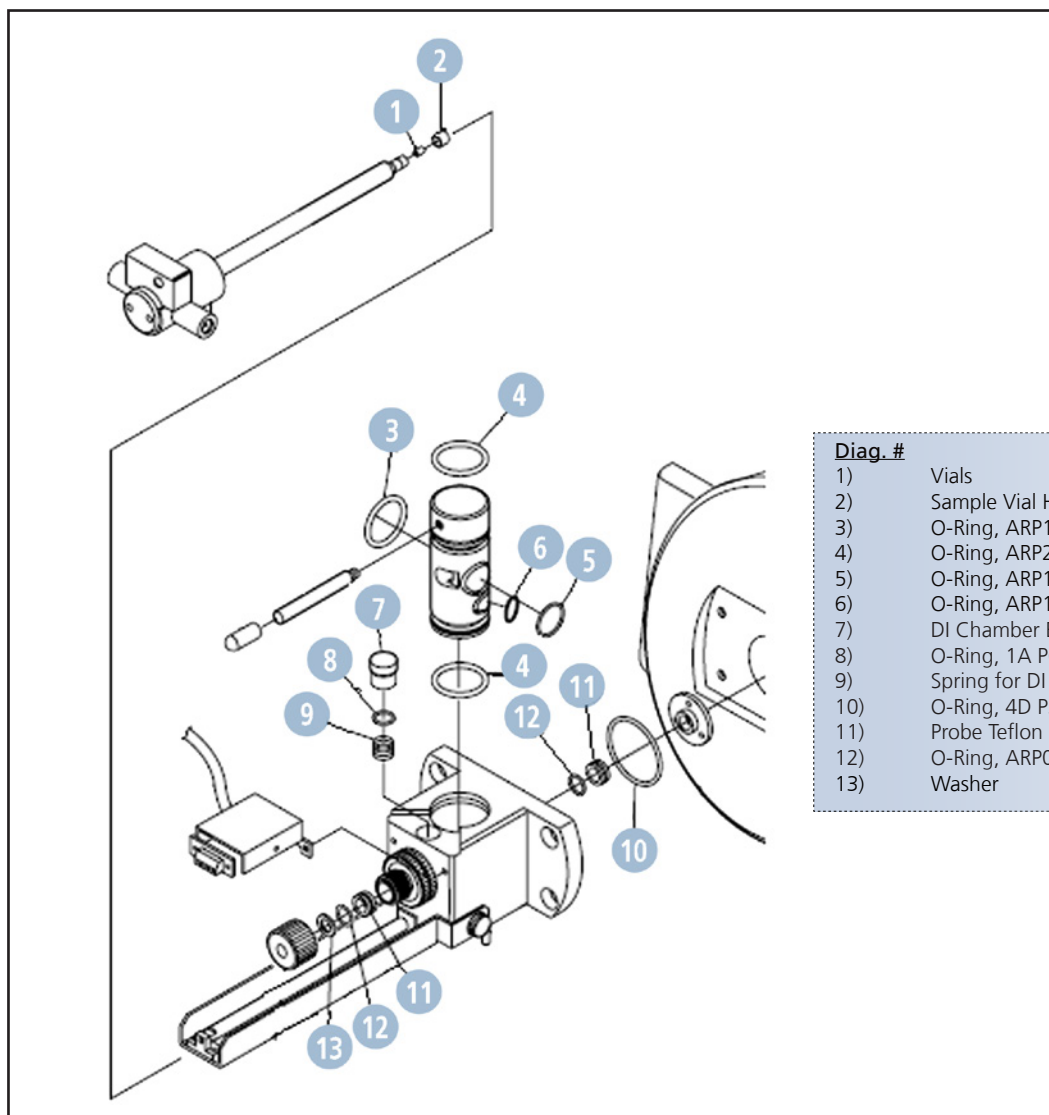

- Diag. #**
- 1) Vials
 - 2) Sample Vial Holding Cap
 - 3) O-Ring, ARP118 4D
 - 4) O-Ring, ARP211 4D
 - 5) O-Ring, ARP113 4D
 - 6) O-Ring, ARP110 4D
 - 7) DI Chamber Button
 - 8) O-Ring, 1A P6 (5 pk)
 - 9) Spring for DI Chamber Button
 - 10) O-Ring, 4D P35
 - 11) Probe Teflon Seals
 - 12) O-Ring, ARP012 4D
 - 13) Washer

DI-2010

Diag. #	Part No.	Name	Description
1	225-09470-00	Quartz vial	Quartz sample vials, 10/pk
1	225-09344-00	Pyrex vials	Pyrex sample vials, 100/pk
2	225-04209-00	Sample vial holding cap	1/pk
3	036-15551-18	O-Ring	O-ring ARP 118 4D
4	036-15552-11	O-Ring	O-ring ARP 211 4D
5	036-15551-13	O-Ring	O-ring ARP 113 4D
6	036-15551-10	O-Ring	O-ring ARP 110 4D
7	225-01206-02	DI chamber button	DI chamber button
8	036-10204-84	O-Ring	O-ring 1A P6, 5/pk
9	225-01207-01	Spring for DI chamber button	Spring for DI chamber button
10	036-11237-00	O-Ring	O-ring 4D P35
11	200-33168-00	Probe Teflon Seals	Teflon seals for probe, 1/pk
12	036-15550-12	O-Ring	O-ring ARP 012 4D
13	202-73225-00	Washer	Washer for DI probe, 1/pk

Tool Kit

Diag. #	Part No.	Name	Description
1	225-10194-91	Ion source removal tool	For removing the ion source from the MS
2	225-11657-08	MS column measurement tool	Tool for measuring proper insertion depth into the MS
3	225-11657-09	INJ column measurement tool	Tool for measuring proper insertion depth into the INJ
4	086-16101-00	Tweezers	For use during MS service
5	086-11002-00	Phillips screwdriver	#2 Phillips screwdriver
6	086-10403-00	Flat-head screwdriver	Flat-head 100mm screwdriver
7	086-12011-00	Hex nut driver, 4mm	For removing the ion source from the MS
8	086-03804-00	Allen wrench, 3mm	Allen wrench, 3mm
9	086-03806-00	Allen wrench, 5mm	Allen wrench, 5mm
10	086-03011-00	Wrench, 10mm and 12mm	Open ended 10mm and 12mm wrench for tubing connections
11	221-46977-00	Injection port wrench	Wrench used to open injection port top for insert/o-ring replacement
	221-35566-92	G-type plug	G-type plug for leak checking injection port, 2/pk
	086-03410-00	Wrench, 1/4 and 5/16	Open ended 1/4 and 5/16 wrench for column nuts
	086-03003-00	Wrench, 6mm and 8mm	Open ended 6mm and 8mm wrench
	086-03818-00	Allen wrench, 1.5mm	Allen wrench, 1.5mm
	225-20051-91	Tool Kit for GCMS	Tool kit that comes with the GCMS unit (for all QP and TQ)

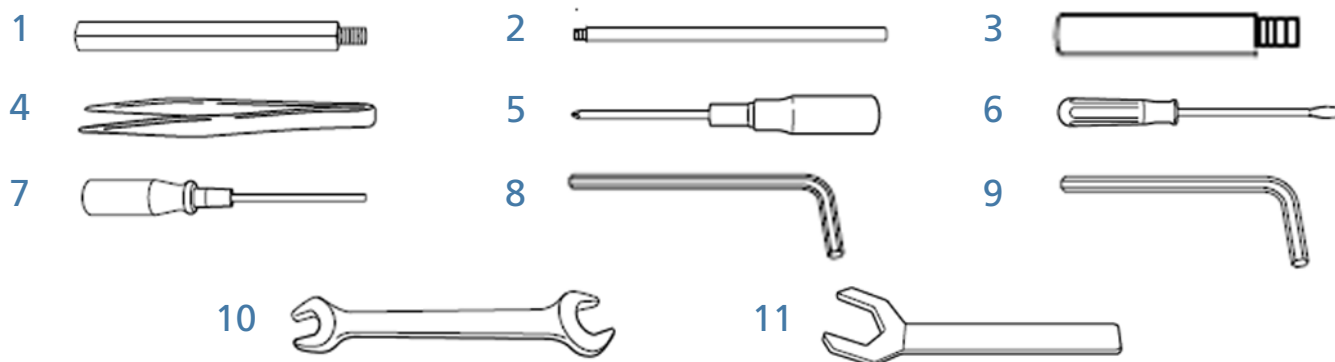

Libraries

Part No.	Name	Description
225-21772-91	NIST Mass Spectral Library 2011	NIST/EPA/NIH mass spectral library, 2011 edition
220-94756-00	Wiley Mass Spectral Library, 9th edition	The Wiley mass spectral library, 9th edition
220-94757-10	Wiley/NIST Mass Spectral Library	The Wiley and NIST mass spectral libraries
220-94760-00	MPW Mass Spectral Library	The Maurer, Pflieger, Weber mass spectral library of drugs, poisons, and pesticides
220-94761-00	Designer Drug Mass Spectral Library	Designer drug mass spectral library, 2012 edition
225-21811-91	Flavor and Fragrance Natural and Synthetic Compounds (FFNSC2) Mass Spectral Library	Mass spectral library of compounds related to natural and synthetic flavors and fragrances
225-17976-92	Pesticide Mass Spectral Library, Version 3	Mass spectral library of pesticides (EI and NCI) acquired on the QP2010 series MS, including analytical method files
225-13126-92	Metabolite Mass Spectral Database	Metabolite mass spectral database with method files, mass spectral libraries, and handbook for easy metabolite identification.
225-13131-92	Forensic Toxicological Database	Mass spectral library for drugs of abuse
220-94774-00	Benzodiazepine Mass Spectral Library	Mass spectral library for benzodiazepine derivatives and metabolites
225-13106-92	Compound Composer Database Software, Version 2	Mass spectral library for compounds of environmental interest, includes calibration data and retention indices

Additional Items

Part No.	Name	Description
220-90775-03	PFTBA Tuning Standard	PFTBA standard 1mL vial
225-04257-91	Glass PFTBA Reservoir	Glass vial the holds PFTBA, 5/pk
225-10180-41	PFTBA Assembly	PFTBA set-up with vial and restrictor
225-09493-01	TRIS	0.5 grams of standard
220-97808-00	Pump Oil, Ultragrade 19	Pump oil for RV 3, 1L container
220-97808-01	Pump Oil, Ultragrade 19	Pump oil for RV 3, 4L container
220-97808-02	Pump Oil, Ultragrade 15	Pump oil for RV 1.5 (E2M 1.5), 1L container
220-94689-00	Oil Mist Filter	Oil mist filter for RV 3
220-94695-00	Oil Mist Filter	Oil mist filter for RV 1.5 (E2M 1.5)
220-94690-00	Oil Return Kit	Oil return kit for RV 3, for use in conjunction with oil mist filter
036-11271-00	O-ring for MS door	O-ring used for sealing the MS front door
220-94697-00	GCMS Four Component Test Mix	Four component mix used for QA testing and install, 1mL
220-94775-00	AART Standard Test Mix	N-alkane test mix for running AART, 1mL
220-94697-01	TQ Standard, OFN	OFN Test Mix 1.0ug/L
220-94697-02	TQ Standard, OFN	OFN Test Mix 0.1ug/L
220-94697-03	TQ Standard, OFN	OFN Test Mix 0.01ug/L
220-94697-04	TQ Standard, Benzophenone	Benzophenone-d10 Test Mix 1ug/L
201-35183-00	Aluminum gaskets	Gaskets used to seal tubing connections with G-type fitting, 100/pk
220-94859-10	Helium carrier filter kit	Gas filter for incoming helium line, includes filter and mounting brackets
220-94859-20	Helium filter replacement cartridge	Replacement cartridge for filter
670-15003-01	Ferrule: GVF-000	Capillary MS ferrule for plugging off the MS or leak testing the injection port , 10/pk
221-48600-00	Silica Wool	Deactivated wool, 2g/container
221-43947-91	Column Holder	Windmill type, allows two holders/columns to be attached in the center together
221-47159-00	Column Holder	Hanger type, allows two holders/columns hung one in front of the other
220-94702-00	Column Cutting tool	Ceramic capillary cutting wafer
221-34618-00	Syringe	Syringe for manual injection/AOC-20i, 0.63 (23 gauge)



SHIMADZU CORPORATION, International Marketing Division

3. Kanda-Nishikicho 1-chome, Chiyoda-ku, Tokyo 101-8448, Japan

Phone: 81(3)3219-5641, Fax: 81(3)3219-5710

URL: www.shimadzu.com

SHIMADZU SCIENTIFIC INSTRUMENTS

7102 Riverwood Drive, Columbia, Maryland 21046, U.S.A.

Phone: 800-477-1227/410-381-1227, Fax: 410-381-1222

URL: www.ssi.shimadzu.com

Webstore URL: store.shimadzu.com

Company names, product/service names and logos used in this publication are trademarks and trade names of Shimadzu Corporation and its affiliates, whether or not they are used with trademark symbol "TM" or "®".

Third-party trademarks and trade names may be used in this publication to refer to either the entities or their products/services. Shimadzu disclaims any proprietary interest in trademarks and trade names other than its own.

For Research Use Only. Not for use in diagnostic procedures.

The contents of this publication are provided to you "as is" without warranty of any kind, and are subject to change without notice. Shimadzu does not assume any responsibility or liability for any damage, whether direct or indirect, relating to the use of this publication.