

# FTIR

## TALK LETTER

vol. 18  
January 2013



Lasers Used in FTIR Systems — 02

Measurement Method ABCs:  
Reflection Absorption Spectroscopy — 05

# Lasers Used in FTIR Systems

Spectroscopy Business Unit, Analytical & Measuring Instruments Division, Hisato Fukuda

In some cases, red light is visible when placing accessories or samples in the sample compartment of Shimadzu FTIR spectrophotometers. This red light is from a helium-neon (HeNe) laser emitted from the FTIR interferometer. So, if FTIR spectrophotometers are based on infrared light, why is a visible HeNe laser used?

## (1) Lasers

"Laser" is an acronym for light amplification by stimulated emission of radiation. The following is a simplified explanation of the principle used to generate lasers. An electric discharge or other means is used to energize the majority of molecules in the laser medium (a mixture of He and Ne gases, in the case of HeNe lasers) to an elevated energy state. When the number of higher energy molecules exceeds the number of lower energy molecules, the state is called a "population inversion" (Fig. 1(a)).

When a population inversion occurs, some of the higher energy molecules emit light as they transition back to the lower energy state. This is called "spontaneous emission" (Fig. 1(b)), which in turn stimulates other molecules in the higher energy state, generating a chain reaction of light emission (Fig. 1(c)). This chain reaction is called "induced emission" and enables producing light, called laser light, with uniform wavelength or phase.

Currently, there are many different lasers made by varying the laser media used, such as solid lasers, semiconductor lasers, and liquid lasers, which are utilized for a wide variety of applications.

Lasers offer the following characteristics.

### (1) They are monochromatic

Unlike natural light, fluorescent lamps, or other light, lasers include only one wavelength of light.

### (2) They have excellent directionality

Laser light travels in a straight path, with very little divergence.

### (3) They have high coherence

The light waves have the same phase and, therefore, are easily made coherent.

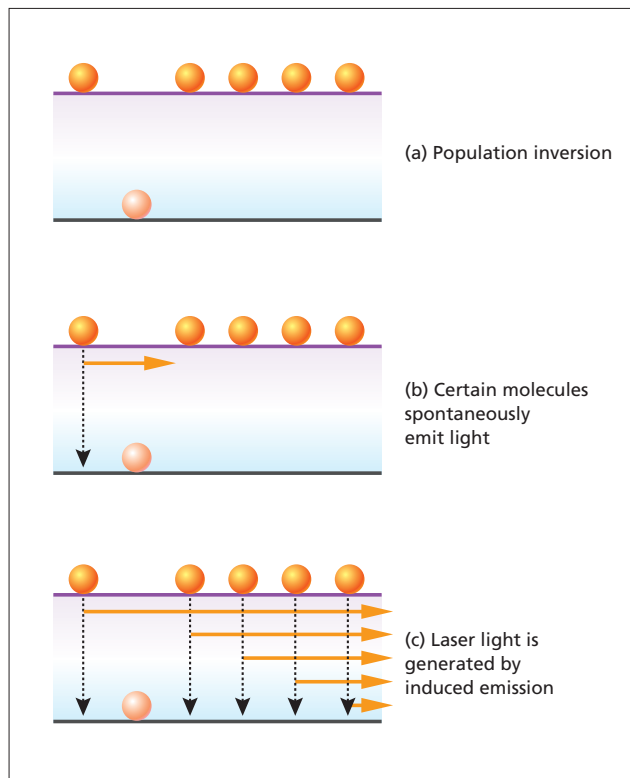

Fig. 1 Principle of How Lasers are Generated by Induced Emission

## (2) Reason Lasers are Used in FTIR Spectrophotometers

A diagram of the interferometer in the Shimadzu IRPrestige-21 is shown in Fig. 2. In Fig. 2, infrared light emitted from the light source is collimated into parallel light by the collimating mirror. This light enters a Michelson interferometer, which comprises a beam splitter (BS), moving mirror, and a fixed mirror. In the Michelson interferometer, the light split via the beam splitter reflects off of the moving and fixed mirrors to recombine at the beam splitter to create an interference pattern.

By moving the moving mirror back and forth, the interfered infrared light creates an interferogram with different amplitudes depending on the position of the moving mirror, which is detected by the infrared detector.

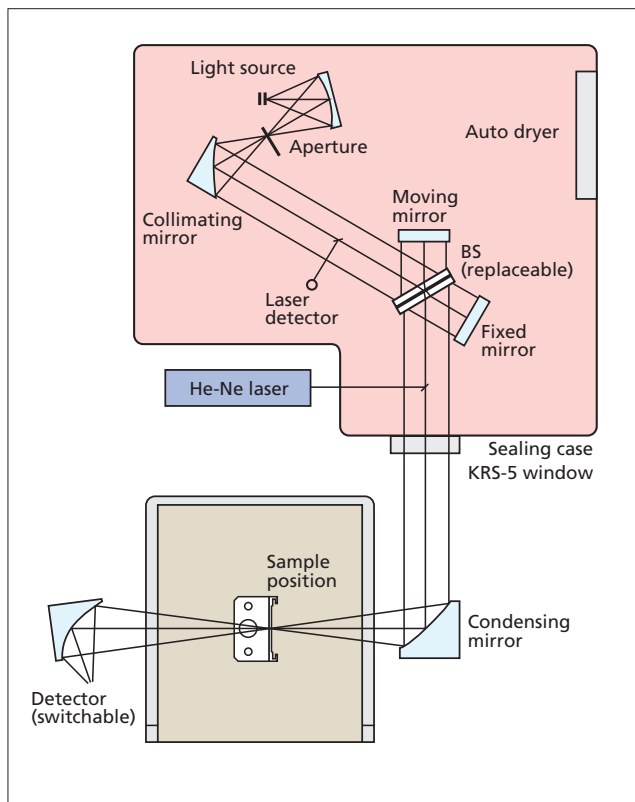

Fig. 2 Schematic of IRPrestige-21 Interferometer

The horizontal axis of the interferogram shows the difference in optical path of light reflected from the moving and fixed mirrors. Applying Fourier transform to this interferogram provides a spectrum with wavelength on the horizontal axis and signal intensity on the vertical axis.

The coherent laser light is used when sampling the interferogram. As shown in Fig. 2, the laser light also enters the Michelson interferometer and is detected by the laser detector as coherent light. The interferogram data is sampled based on the signal from the laser detector (see Fig. 3).

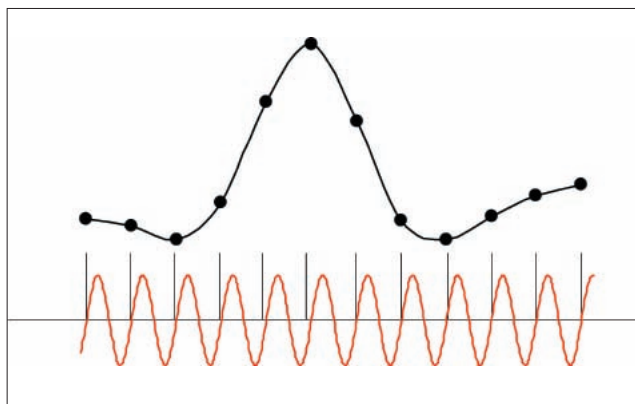

Fig. 3 Sampling Interferogram Data Using the Laser Interference Signal

In other words, the laser light functions as scale for accurately measuring the difference in optical paths, which is indicated on the horizontal axis of the interferogram. A laser with a constant wavelength is also used to maintain the same level of wavenumber precision for sample and background measurements by eliminating deviations in the horizontal axis. Since HeNe lasers provide higher wavelength precision than other lasers, they are commonly used in FTIR systems.

In addition to data sampling, the coherent laser light is also used for a dynamic alignment mechanism. Dynamic alignment monitors the coherence of the laser and compares it to optimal coherence recorded in the system. It does so to continuously vary the fixed mirror angle to compensate for any deviation from the optimal value and enable measurements under stable conditions.

The automatic adjustment command in IRsolution is used to search for the optimal coherence state and record it in the system.

Thus, the laser serves a vital role in FTIR systems and, consequently, Shimadzu provides an especially long warranty period for lasers. The laser emission status can be confirmed in the status window in IRsolution.

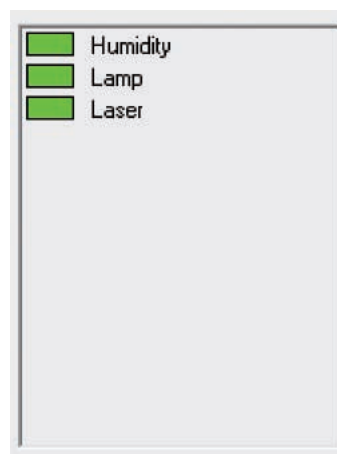

Fig. 4 Status Window in IRsolution

### (3) Safety and Laser Classifications

As mentioned above, the red light visible in the sample compartment is from the laser. Is it a problem if it shines into your eyes? No, Shimadzu's IRAffinity-1 and IRPrestige-21 systems use Class 1 lasers (see Fig. 5), which are safe even if light from the sample compartment enters the eyes.

Safety standards for laser products are specified in the international standard IEC 60825-1. In Japan, JIS C 6802 specifies standards based on IEC 60825-1.

JIS C 6802 classifies laser products into seven classes, based on their danger level. For reference purposes, the classes are described in Table 1.



Fig. 5 IRAffinity-1

Table 1 Laser Classifications

Class	Description
Class 1	Inherently safe.
Class 1M	Safe to look at with bare eyes. In some cases, viewing 1M lasers using optical devices (such as a magnifying glass or binoculars) may be dangerous.
Class 2	Applicable to visible light lasers from 400 to 700 nm. Eyes can be protected through measures to avoid the light, such as by blinking.
Class 2M	Applicable to visible light lasers from 400 to 700 nm. Eyes can be protected through measures to avoid the light, such as by blinking. However, in some cases, viewing 2M lasers using optical devices could be dangerous.
Class 3R	Looking directly at the laser beam could be dangerous in some cases.
Class 3B	Looking directly at the laser beam is dangerous. Viewing diffused reflected light is normally safe.
Class 4	Viewing diffused reflected light is also dangerous.

# Measurement Method ABCs: Reflection Absorption Spectroscopy

Global Application Development Center, Analytical & Measuring Instruments Division,  
Sachio Murakami

Various measurement methods are used in Fourier transform infrared spectrophotometers (FTIR). Of these methods, the potassium bromide (KBr) pellet, liquid film, diffuse reflectance, and specular reflection methods have been described in *FTIR Talk Letter* Volumes 14 to 17. This article discusses reflection absorption spectroscopy (RAF), which is primarily used for analyzing thin films formed on metal substrates, based on an actual example, focusing on the differences in infrared spectra obtained using different incident angles or polarizers.

## 1. Reflection Absorption Spectroscopy

Reflection absorption spectroscopy is used primarily to measure organic films formed on metal substrates. Just as with the specular reflection method described in Volume 17, it detects the light reflected at the same angle as the incident angle. Whereas the specular reflection method irradiates the sample with infrared light at a nearly perpendicular angle of incidence, the reflection absorption method measures samples by irradiating them with infrared light at a near-level angle of 70 to 85 degrees. This method is used to analyze extremely thin films, such as Langmuir-Blodgett (LB) films, or to research molecular orientation. Incident light and reflected light for a film on a metal substrate is illustrated in Fig. 1.

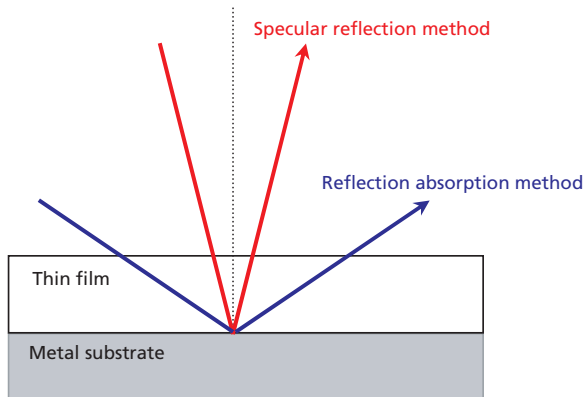

Fig. 1 Incident and Reflected Light for a Thin Film on a Metal Substrate

With the specular reflection method, light hits the sample at an angle close to normal, but with the reflection absorption method, the light hits the sample at an angle between 70 and 85 degrees. Increasing the incident angle increases the path length of light penetrating the film, which enables measuring thinner films.

In the case of reflection absorption method with larger incident angles, polarized light increases sensitivity more than the effect of the light path length mentioned above.

For both incident and reflected light, if a plane perpendicular to the metal substrate is defined as the incident plane, then light with an electric field vector parallel to the incident plane is parallel polarized (p-polarized) light, whereas light with an electric field vector perpendicular to the incident plane is perpendicular polarized (s-polarized) light.

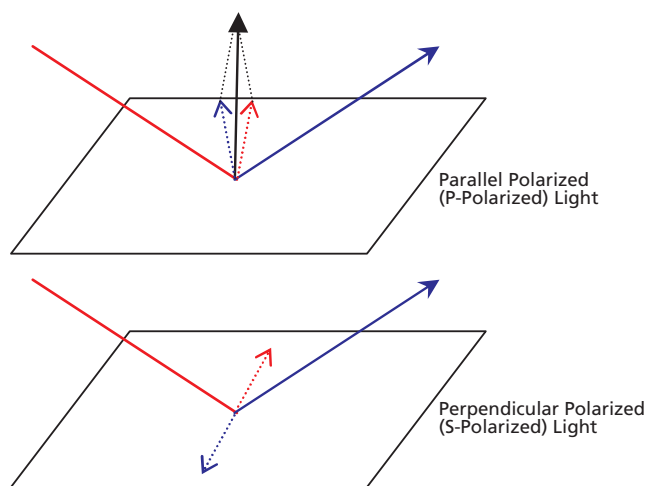

Fig. 2 Oscillation of Polarized Light Incident on a Metal Surface

Since the electric field vector of parallel polarized (p-polarized) light is parallel to the incident plane, it forms a standing wave. The amplitude of the standing wave, and consequently the peak intensity as well, increases as the incident angle is increased. In contrast, the electric field vectors of perpendicular polarized (s-polarized) light cancel each other out, so almost no standing wave is formed. Therefore, the peak intensity is extremely small.

Using a polarizer to filter out this perpendicular polarized (s-polarized) light allows further increasing peak intensity.<sup>1)-3)</sup>

## 2. Reflection Absorption Spectroscopy Accessory

Fig. 3 shows a VeeMAX II variable angle of incidence reflectance attachment. The VeeMAX II allows varying the angle of incidence between 30 and 80 degrees and attaching an optional polarizer.



Fig. 3 VeeMAX II Variable Angle of Incidence Reflectance Attachment

## 3. Analysis of LB Film on an Aluminum Mirror

### 3-1. Spectrum of LB Film on an Aluminum Mirror

Fig. 4 shows an infrared spectrum of an LB film (cadmium stearate) formed on the surface of an aluminum mirror, measured at an incident angle of 70 degrees.

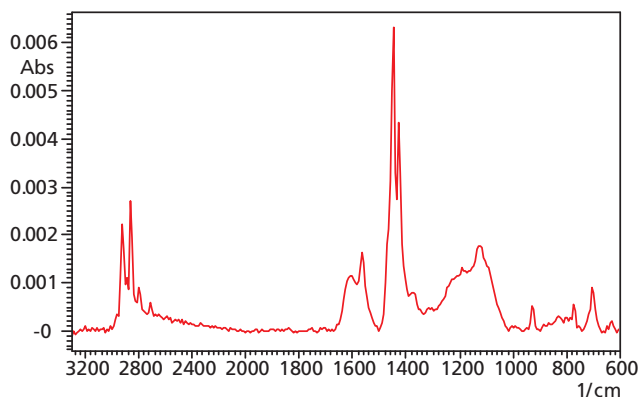

Fig. 4 Infrared Spectrum of LB Film on an Aluminum Mirror

The cadmium stearate film is connected to the substrate via its  $\text{COO}^-$  group, with its primary chain  $(\text{CH}_2)_{16}^-$  extending perpendicularly from the substrate. The reflection absorption method detects vibrations perpendicular to the substrate. Therefore, it increases the peak intensity near  $1450 \text{ cm}^{-1}$ , due to symmetric  $\text{COO}^-$  stretching vibration.

If the transmittance method is used to measure the LB film above, it will detect vibrations parallel to the substrate (C-H stretching vibration near  $2900 \text{ cm}^{-1}$ ). Therefore, it provides a different infrared spectrum than the reflection absorption method.

### 3-2. Angle of Incidence

An overlay of infrared spectra measured at incident angles of 70, 75, and 80 degrees is shown in Fig. 5. The area around  $1400 \text{ cm}^{-1}$  was enlarged to make it easier to see the relationship between sample peak intensity and angle of incidence.

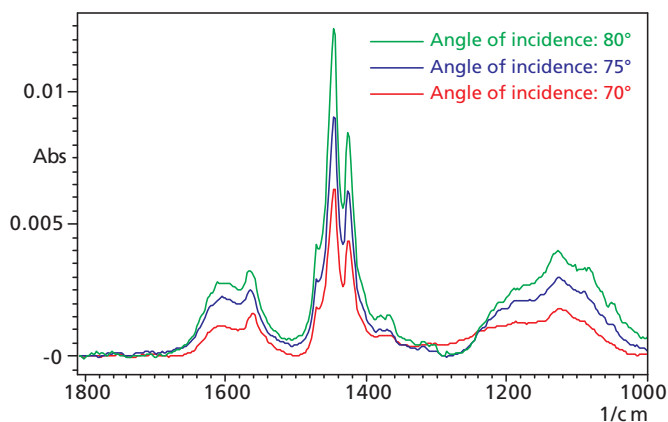

Fig. 5 Relationship Between Infrared Spectra and Angle of Incidence

Fig. 5 shows that the larger the angle of incidence, the higher the peak intensity. However, increasing the angle of incidence decreases the amount of infrared light available for measurement. Therefore, it tends to increase noise.

### 3-3. Using Polarizers

Fig. 6 shows an overlay of infrared spectra measured with and without a polarizer. The angle of incidence was 80 degrees.

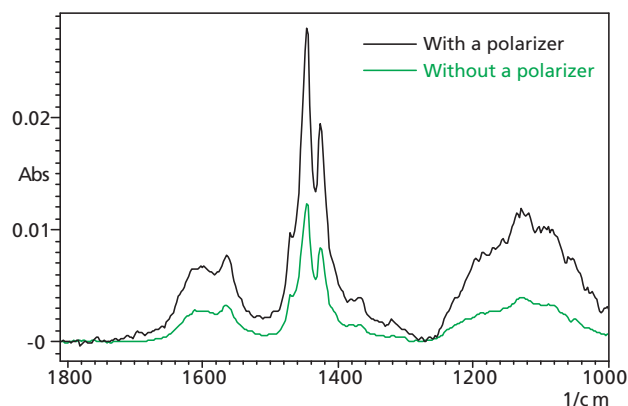

Fig. 6 Differences in Infrared Spectra With and Without a Polarizer

Fig. 6 shows that using a polarizer to detect only parallel polarized (p-polarized) light further increased peak intensity. However, using a polarizer decreases the amount of infrared light available for measurement. Therefore, it increases noise. If noise increases, it is recommended that the number of integrations be increased, or an MCT detector, which maintains high sensitivity even when the amount of light is inadequate, be used.

---

## References

- 1) *Practical Spectroscopy Methods Series 2 – Infrared Spectroscopy*  
Written and edited by Yukihiro Ozaki, Industrial Publishing & Consulting, Inc.
- 2) *Instrumental Analysis Skills Series 2 – Infrared Spectroscopy*  
Written by Shigeyuki Tanaka and Norio Teramae, Kyoritsu Shuppan Co., Ltd.
- 3) *Journal of SPSJ* Vol. 59, No. 5, pp. 248–260 (2010)  
Koji Masatani and Shukichi Ochiai, The Spectroscopical Society of Japan



Shimadzu Corporation

[www.shimadzu.com/an/](http://www.shimadzu.com/an/)

Company names, product/service names and logos used in this publication are trademarks and trade names of Shimadzu Corporation or its affiliates, whether or not they are used with trademark symbol "TM" or "®".  
Third-party trademarks and trade names may be used in this publication to refer to either the entities or their products/services. Shimadzu disclaims any proprietary interest in trademarks and trade names other than its own.

For Research Use Only. Not for use in diagnostic procedures.  
The contents of this publication are provided to you "as is" without warranty of any kind, and are subject to change without notice. Shimadzu does not assume any responsibility or liability for any damage, whether direct or indirect, relating to the use of this publication.

© Shimadzu Corporation, 2013

Printed in Japan 3655-07216-15ANS