

# New Applications Using GC BID Detector

**Pittcon 2014** 530-1P

Zhuangzhi "Max" Wang, Nicole Lock,  
Richard Whitney, Clifford M. Taylor  
Shimadzu Scientific Instruments, Columbia, MD

## New Applications Using GC BID Detector

### Introduction

The Barrier Ionization Discharge (BID) detector generates a 17.7 eV helium plasma that ionizes almost all compounds except Neon. A newly designed quartz dielectric chamber allows for a lower discharge current and higher operating temperature. The BID is a universal detector with sensitivity greater than 100 times that of a TCD. It is an ideal detector for trace levels of permanent gas, water, volatile fatty acids and light hydrocarbons.

Two customized GC applications are presented. Two 6-port valves are used to inject, trap and release permanent gases. A 4-port switching valve was used to direct high concentration sample components to a TCD.



### Materials and Methods

#### BID-2010 Plus Principals for Detection

A plasma is generated by applying a high voltage to a quartz dielectric chamber, in the presence of helium. Compounds that elute from the GC column are ionized by this He plasma, then captured with collection electrodes and described as peaks. The photon energy of He is extremely high (17.7 electron volt). Therefore it makes possible to detect every compound except Ne (neon) and He which is the plasma gas, with high sensitivity. BID is truly a universal plasma detector.

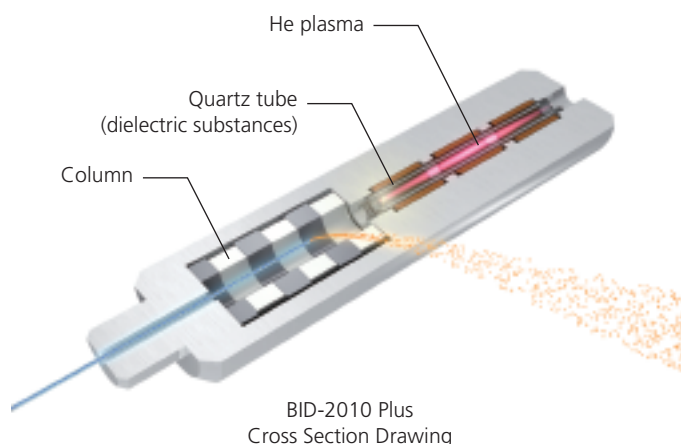

BID was developed thru collaborative research with Dr. Katsuhisa Kitano, Center of Atomic and Molecular Technologies, Graduate School of Engineering, Osaka University, resulting in 3 U.S. patents and 4 patents pending.

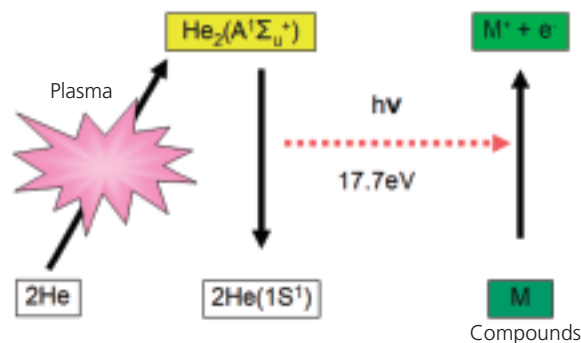

Principle of Ionization Reaction

## New Applications Using GC BID Detector

### Structure of BID

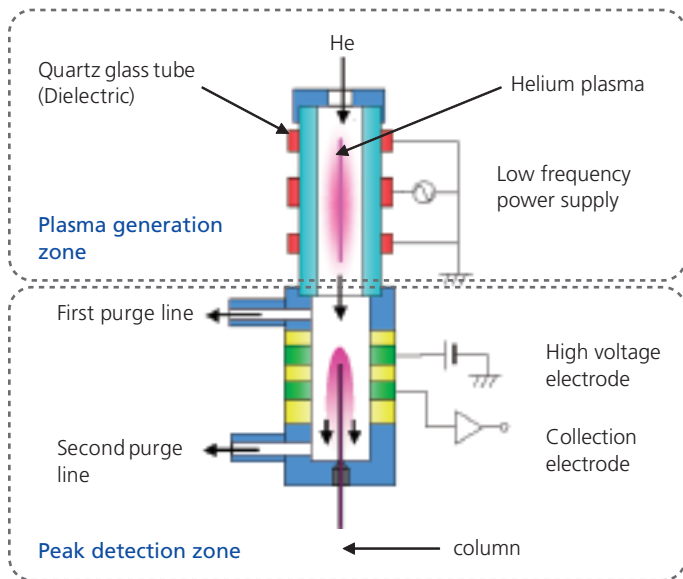

Structure of BID

Three electrodes are placed on the quartz tube. High voltage is applied to electrodes, and plasma is generated

Compounds are ionized by plasma, and signal is collected at collection electrode

### Features of BID-2010 Plus

BID-2010 Plus of Tracera is a novel universal detector based on dielectric barrier plasma ionization. Tracera makes it possible to conduct many kinds of applications and achieve simple and high sensitive analysis.

#### 1. High Sensitivity

Detection Sensitivity over 100x Higher Than TCD,  
2x Higher than FID

#### 2. Novel Universal Detector

Single Detector Approach for Your Complex Analyses

#### 3. Long-Term Stability

Long-Term Stability with New Discharge Design

### The BID can replace multiple detection schemes

Analysis of H<sub>2</sub>, O<sub>2</sub>, N<sub>2</sub>, CH<sub>4</sub>, CO

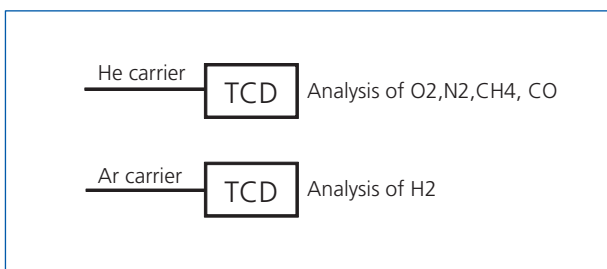

Using two TCDs

Analysis of ppm level of CO, CO<sub>2</sub>

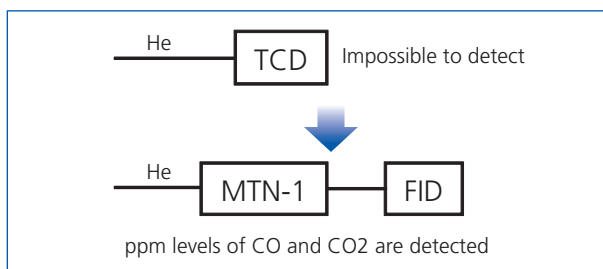

Using a Methanizer and FID

**BID will detect all of these analytes at low levels**

## New Applications Using GC BID Detector

### GC-2010Plus BID with Valves

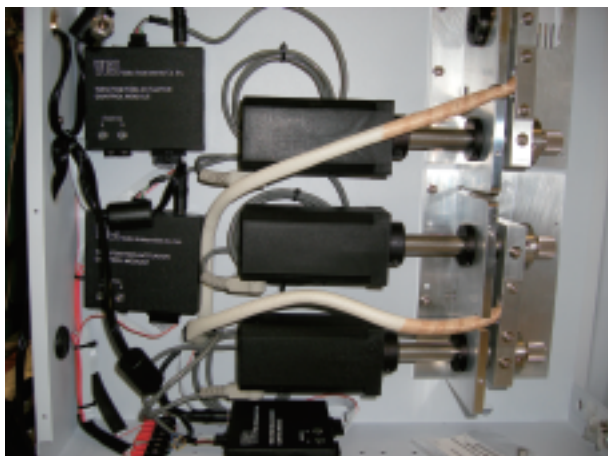

Main body of BID-2010 Plus

### System I

- Permanent gases are trapped in a MolSieve column, and then released and analyzed by BID.
- Light hydrocarbons are analyzed by the BID directly, bypassing the MolSieve column.

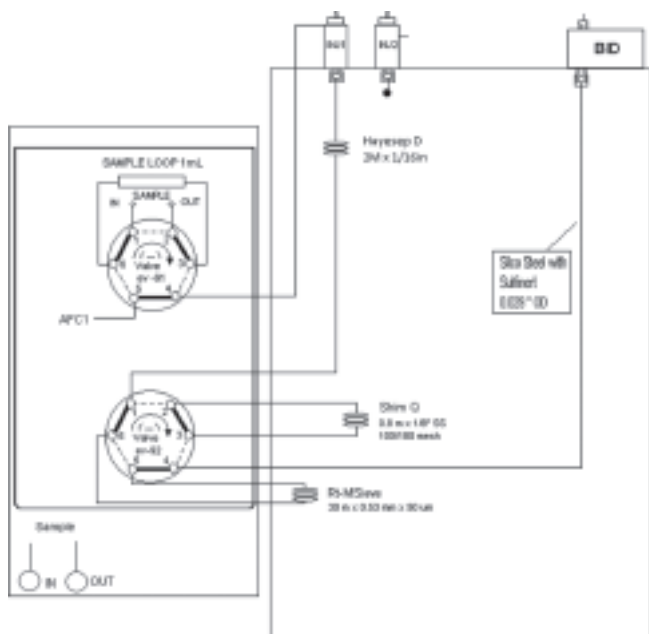

### System I Chromatogram

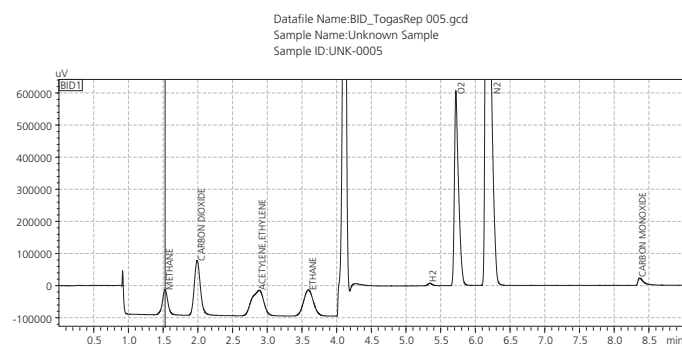

|                     | Hydrogen | Oxygen | Nitrogen | Methane | Carbon Monoxide | Carbon Dioxide | Ethylene | Ethane | Acetylene |
|---------------------|----------|--------|----------|---------|-----------------|----------------|----------|--------|-----------|
| Concentration (ppm) | 100      | 2500   | 16900    | 100     | 100             | 400            | 100      | 100    | 100       |

# New Applications Using GC BID Detector

## System I Standard Repeatability

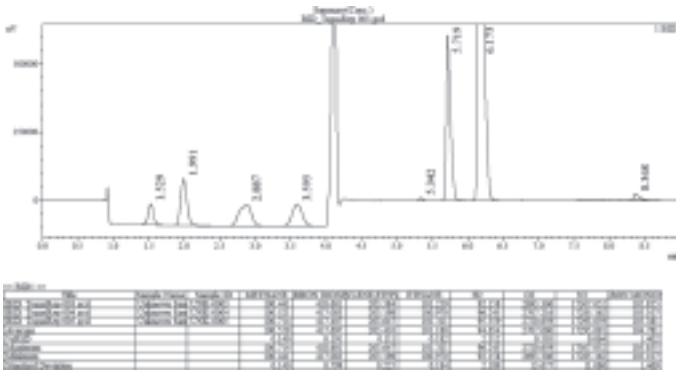

## System I Hydrocarbon Standard

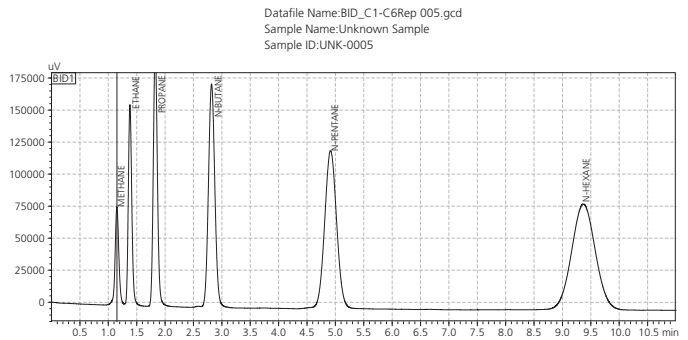

|                     | Methane | Ethane | Propane | N-Butane | N-Pentane | N-Hexane |
|---------------------|---------|--------|---------|----------|-----------|----------|
| Concentration (ppm) | 100     | 100    | 400     | 100      | 100       | 100      |

## System I Hydrocarbon Standard Repeatability

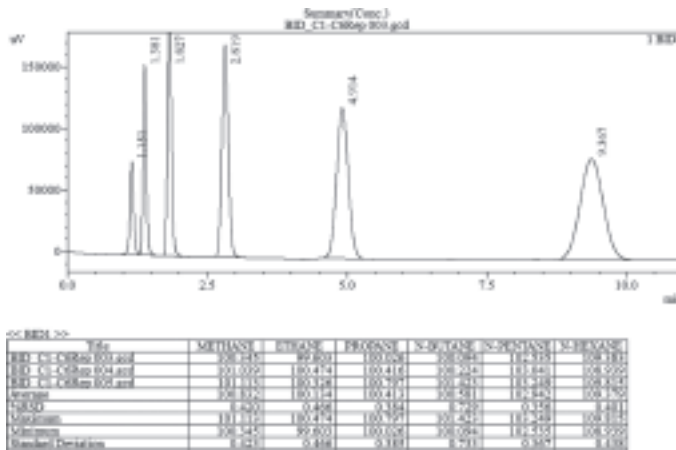

## System II

- Permanent gases are trapped in a MolSieve column, and then released and analyzed by BID.
- High concentration sample components are directed to the TCD via a 4 port switching valve.

DDF000210-GC-2010AT with BID

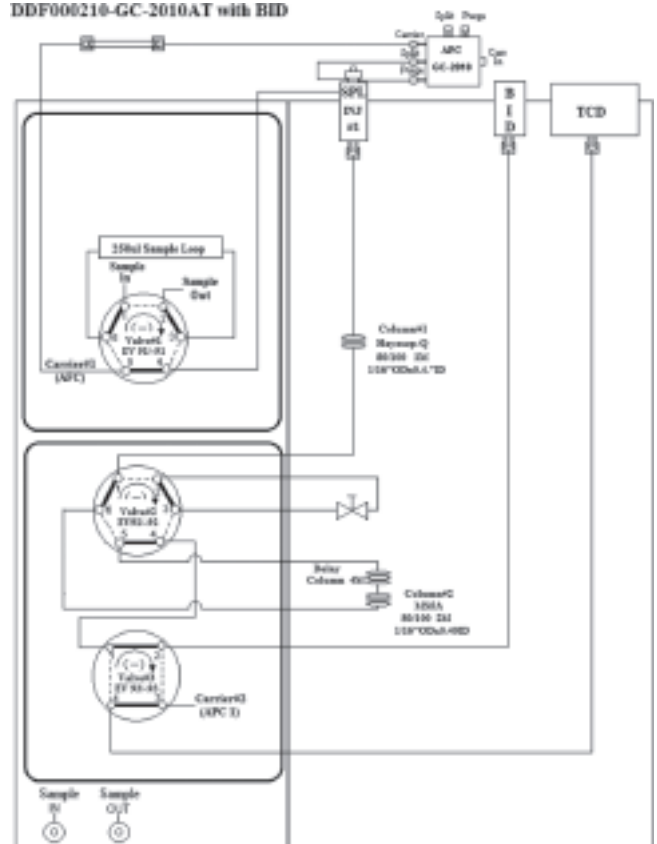

## New Applications Using GC BID Detector

### System II Low Standard- BID

Datafile Name:DDF210-BID-11-8-13-006.gcd  
Sample Name:HIGH GAS STD  
Sample ID:DDF210-BID-11-8-13-006

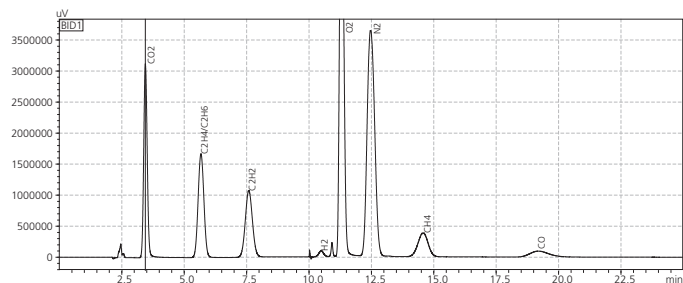

|                     | Hydrogen | Oxygen | Nitrogen | Methane | Carbon Monoxide | Carbon Dioxide | Ethylene | Ethane | Acetylene |
|---------------------|----------|--------|----------|---------|-----------------|----------------|----------|--------|-----------|
| Concentration (ppm) | 100      | 2500   | 16900    | 100     | 100             | 400            | 100      | 100    | 100       |

### System II High Standard - TCD

Datafile Name:DDF210-TCD only-11-12-13-006.gcd  
Sample Name:High Gas STD  
Sample ID:DDF210-TCD only-11-12-13-006

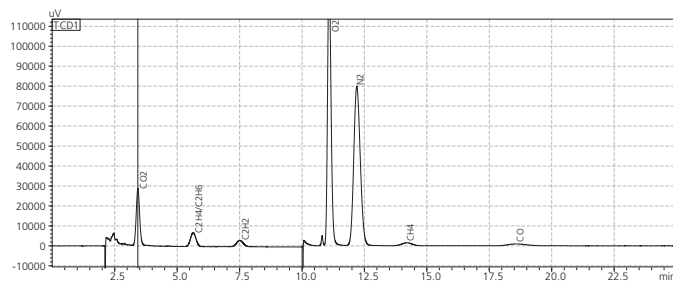

|                     | Hydrogen | Oxygen | Nitrogen | Methane | Carbon Monoxide | Carbon Dioxide | Ethylene | Ethane | Acetylene |
|---------------------|----------|--------|----------|---------|-----------------|----------------|----------|--------|-----------|
| Concentration (ppm) | 4990     | 125310 | 829675   | 3740    | 5000            | 20040          | 3750     | 3750   | 3745      |

## Conclusions

- The new Shimadzu GC BID is a universal, sensitive, and rugged detector that can be used in a variety of applications.



First Edition: March, 2014